



FORGET HUMIDITY FOR EVER!



EU STANDARDS

The equipment comply to all of the applicable EU directives and regulations.



MADE IN EUROPE

All components made exclusively by European manufacturers.



VAST EXPERIENCE

Practical experience in the desiccant dehumidification more than 15 years.



TECHNICAL DATASHEET

Desiccant dehumidifier MDC 6000

GENERAL INFORMATION

Desiccant dehumidifier MDC 6000 designed for general purposes – room air dehumidification and process drying. The compact construction allows extended periods of operation with a minimum of maintenance. Especially suitable for low temperature

and low humidity operation. Unit includes desiccant rotor, ECfans, reactivation heater, pocket filters and controls. Panels insulated with 40 mm rock wool insulation.

In addition to above mentioned application, desiccant dehumidifiers are irreplaceable in:



Protecting against window condensation and glass ceiling in the administrative as well as residential buildings.



Improving the quality of the finishing works during apartment repairs due to drying without thermal movements in the covering products used for walls, floor and ceiling.



Elimination of the effects of the floods, drying new buildings.



Increasing the shelf life of hygroscopic materials: medicines, detergents, building materials and other bulk materials.



Maintaining a low level of humidity during the production of food items as well as products made of wood, rubber and plastic, during the manufacture of furs.



Maintaining the marketable condition of clothing and packaging items.



Reducing the growth of bacteria, etc.

METHOD OF OPERATION

A desiccant dehumidifier removes water from a flow of the air that passes through it. The heart of this process is an adsorption rotor coated with a special substance that absorbs the water molecules that make up the moisture in the passing air (Process air).

When saturated, the rotor is rotated over to a regeneration zone, where it is dried with heated air (Reactivation air). The warm, humid regeneration air is led away out of the unit (Wet air) and the rotor is once again ready to absorb water molecules.

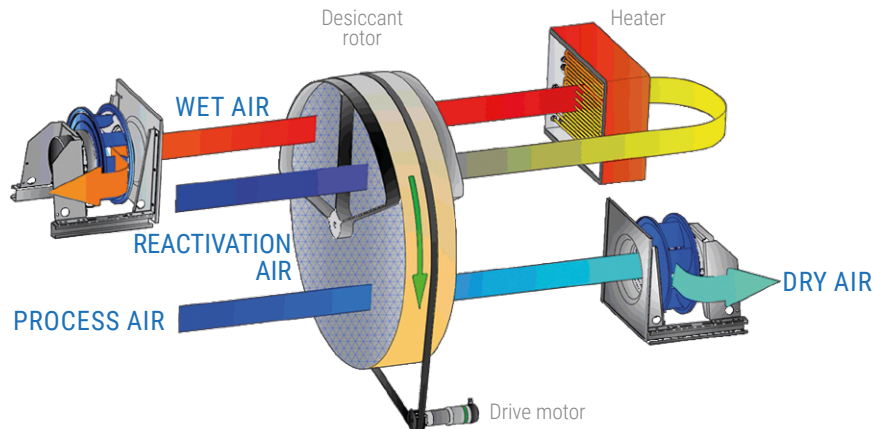

CONSTRUCTIONAL FEATURES

- The casing is completely hermetic and panels are made of 1,0mm AluZinc sheet metal with isolation of 40mm (rock wool); it has high resistance to atmospheric corrosion. Powder painted panels (outside only); rigid frame made of 1,5 mm AluZinc sheet metal (powder painted completely) to achieve rigidity;
- Compact design and low weight of the unit;
- High performance at low temperatures and low relative humidity in a room;
- Optional humidistat is available as an accessory;
- Microprocessor based control (optional);
- Tubular electric heating elements for regeneration (standard unit) as well as on request with water, steam or gas heating coil (customized unit);
- Easy access to the internal components of the dehumidifier for the maintenance;
- EC-fans;
- Pocket filters G4 to F9 on request;
- High efficiency of the washable silica gel rotor;
- All components made exclusively by European manufacturers.

TECHNICAL DATA

Process air	
Rated airflow	3535 CFM 6000 m ³ /h
Available static pressure	400 Pa
Reactivation air	
Rated airflow	1000 CFM 1700 m ³ /h
Available static pressure	320 Pa
Power supply (electric reactivation)	
(3x480V, 60 Hz)	56 kW
Current	81 A
Power supply (steam/water/gas reactivation)	
(3x480V, 60 Hz)	8 kW
Current	12 A

Miscellaneous data	
Dehumidification capacity (at 68°F (20 °C), 60%RH)	86.86 lb/h 39,4 kg/h
Weight	1896 lbs 860 kg
Operating temperature	-22/+104°F -30/+40°C
Max noise level without ductworks	70 dBA
Air filter	EU4÷EU9
IEC protective class	IP55
Insulation	40 mm

DEHUMIDIFICATION CAPACITY

	50%	60%	70%	80%	90%
41°F 5°C	17,6	20,2	23,2	25,7	28,2
50°F 10°C	23,2	26,9	29,7	32,8	35,4
68°F 20°C	35,3	39,4	42,3	44,6	46,4
86°F 30°C	43,2	45,7	47,0	48,0	48,2

Approximate capacity in kg/h at different inlet process air relative humidity (%) and temperature (°C)

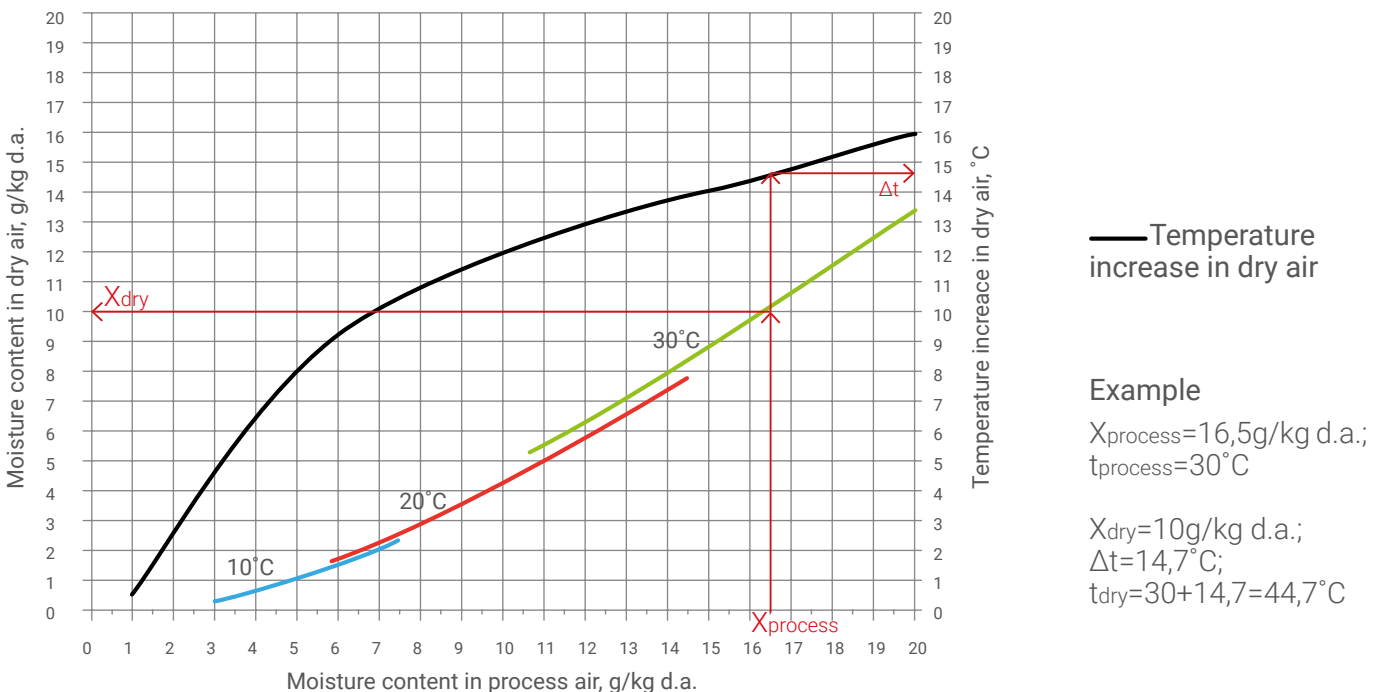

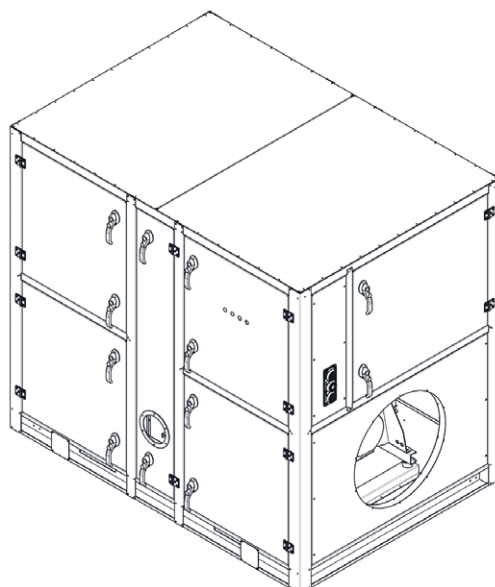
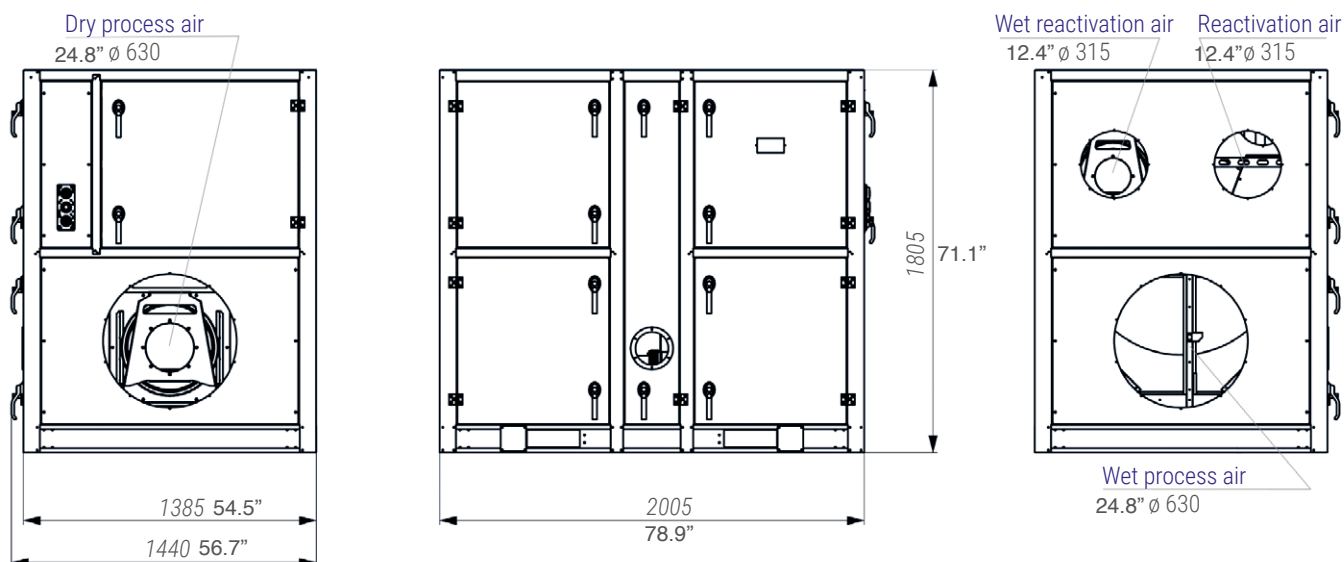

Changes are possible without notice.



UAB DESICCANT TECHNOLOGIES GROUP

E-mail: info@visionaq.com Ph.: +1 825 925 56 55 www.visionaq.com